

CUSTOMER COPY

REV.	DESCRIPTION	APP.	DATE
A	NEW DESIGN	Amos	2010-03-24

ORDER INFORMATION

1206 5 3 0 XX X

- 1:Plating Tin
- No. of Contact
- 3:90° DIP
- 5:JST ZH Type

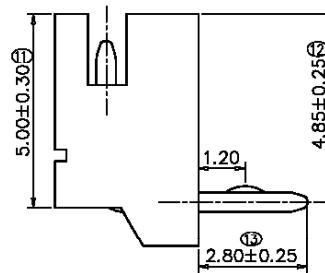
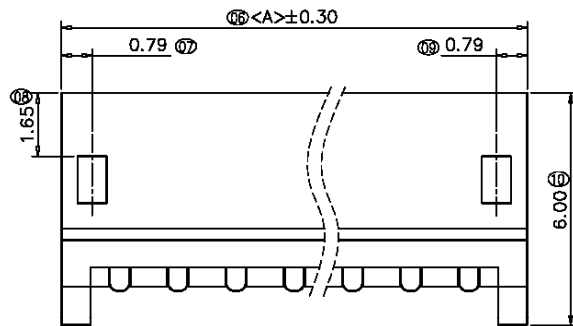
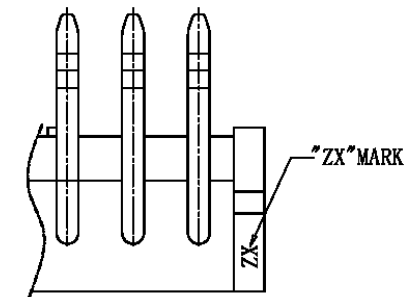
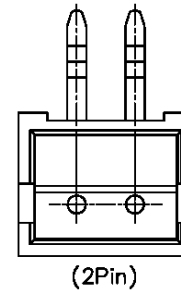
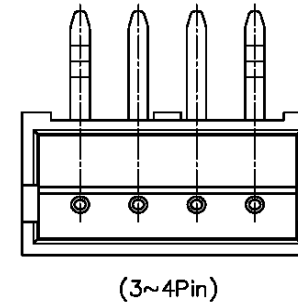
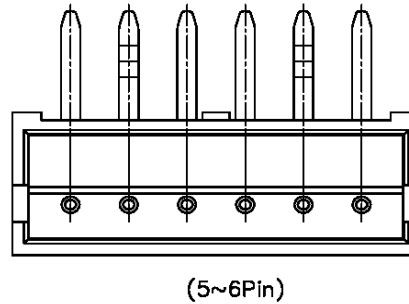
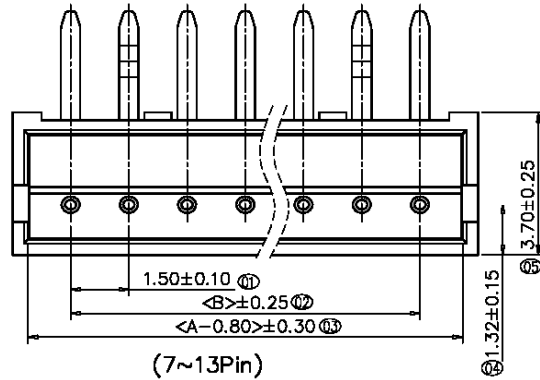

NOTES:

- CURRENT RATING: 1A AC/DC.
- VOLTAGE RATING: 50V AC/DC.
- TEMPERATURE RANGE: -25°C~+85°C.
- CONTACT RESISTANCE: 20mΩ MAX.
- INSULATION RESISTANCE: 500MΩ MIN.
- WITHSTANDING VOLTAGE: 500V AC/MINUTE.

PART NO.	Dimensions	
	A	B
02	4.50	1.50
03	6.00	3.00
04	7.50	4.50
05	9.00	6.00
06	10.50	7.50
07	12.00	9.00
08	13.50	10.50
09	15.00	12.00
10	16.50	13.50
11	18.00	15.00
12	19.50	16.50
13	21.00	18.00

Recommended P.C.B Layout (Top Side)
P.C.B Thickness = 1.20mm
(Tolerance = ±0.05)

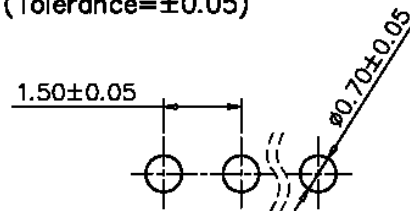

RoHS

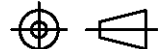
 鈺滿榮企業股份有限公司 ACMELUX CO., LTD. TEL: 886-2-85124595 FAX: 886-2-85124322		TITLE:	
		Pitch 1.5mm 90° JST ZH Type Wafer Connector	
0.0±0.30	SCALE: 1:1	PART NO:	
0.00±0.20	UNIT: mm	APP BY: <i>Hung</i>	
0.000±0.1		CHK BY: <i>Cheryl</i>	
		MATL: RoHS	DR BY: <i>Amos</i>
DWG. NO. C1206530XXX		A303	